

MADE IN ITALY

3-YEAR WARRANTY
GARANZIA 3 ANNI



OIL-FREE COMPRESSORS
COMPRESSORI A SECCO

SUCTIONS
ASPIRAZIONI

DISINFECTION SYSTEMS
DISPOSITIVI DI SANIFICAZIONE

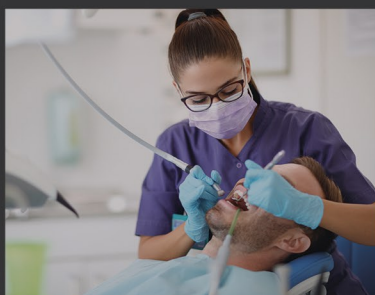



TABLE OF CONTENTS INDICE

OIL-FREE PISTON COMPRESSORS *COMPRESSORI A PISTONI A SECCO*

SMART SERIES.....	07
CLINIC SERIES.....	19

SOUNDPROOFING CABINETS FOR PISTON COMPRESSORS <i>MOBILI INSONORIZZANTI PER COMPRESSORI A PISTONI</i>	27
---	----

OIL-FREE SCROLL COMPRESSORS <i>COMPRESSORI SCROLL A SECCO</i>	31
--	----

SEMI-WET SUCTION SYSTEMS <i>ASPIRAZIONI AD ANELLO UMIDO</i>	35
--	----

ENVIRONMENTAL DISINFECTION SYSTEMS <i>SISTEMI DI SANIFICAZIONE AMBIENTALE</i>	41
--	----

ACCESSORIES AND SERVICE PARTS <i>ACCESSORI E RICAMBI</i>	45
---	----



HUMBLE BEGINNINGS. Gentilin srl was founded 40 years ago in Trissino (Vicenza - Italy), a region particularly known in Europe and throughout the world for its superior standards in mechatronics. In just a few years, the company became a benchmark of excellence for the manufacturing and development of compressed air products. Brothers Giampaolo and Giuseppe Gentilin started in 1980 producing compressed air fittings from their garage. Distribution was initially in Italy and soon after throughout Mediterranean Europe where the Gentilin brothers got to know the peculiar needs of a large compressed air market. Having further diversified the product offering, in 2005 they launched the first line of compressors in the world conceptually developed to work without the need of lubricants. This fundamental milestone became a launching pad for the company in international markets.

UN UMILE MA TENACE INIZIO. *Gentilin srl nasce 40 anni fa a Trissino (Vicenza) in quello che, allora come oggi, è uno dei distretti d'eccellenza della meccatronica a livello europeo e mondiale. In pochi anni l'azienda diventa uno dei punti di riferimento per la produzione, lo sviluppo e la distribuzione di prodotti per l'aria compressa. I fratelli Giampaolo e Giuseppe Gentilin iniziano la loro attività nel 1980 nel garage della loro abitazione. La distribuzione avviene dapprima in Italia e in seguito nell'Europa Mediterranea dove i fratelli Gentilin apprendono le peculiarità e le necessità del vasto settore dell'aria compressa. Diversificando ulteriormente la linea di prodotti offerti nel 2005 viene lanciata la prima gamma al mondo di compressori concettualmente sviluppati per lavorare a secco (senza olio lubrificante). Questo fondamentale passo diventa un grande trampolino di lancio per l'azienda nei mercati internazionali.*



GENTILIN TODAY. The determination of the Gentilin brothers resulted in an important outcome. The company evolved in recent years and onboard are now Alessandra, Giorgio and Riccardo Gentilin, the executive team handling strategy and day-to-day management. The energy and exuberance of the second generation have brought a fresh managerial approach to best practices. More importantly, they taken the legendary focus on research and development to the next level. The company has further consolidated its market presence and has successfully ventured into new segments. Making zero compromises, the result is a range of unique products and services, especially designed for the professional user.

GENTILIN OGGI. *La mission dei fratelli Gentilin ha un seguito importante. L'evoluzione dell'azienda avvenuta negli ultimi anni porta i nomi di Alessandra, Giorgio e Riccardo Gentilin, che formano oggi il team esecutivo al comando di strategia ed operatività del gruppo. La dinamicità ed energia della seconda generazione, uniti al costante focus sull'innovazione e ad una nuova impronta manageriale, hanno permesso all'azienda di consolidare la presenza nei mercati di riferimento e di spingersi ben oltre abbracciando nuovi settori e canali. Il risultato è una gamma di prodotti e servizi unici, senza compromessi, studiati appositamente per il professionista.*



products video

OIL-FREE
SENZA OLIO

PURE AIR
ARIA PURA

HIGHER-EFFICIENCY
PIÙ EFFICIENTI

LONGER LIFE
PIÙ DURATURI

LOWER NOISE
PIÙ SILENZIOSI

3-YEAR WARRANTY
GARANZIA 3 ANNI

MADE IN ITALY
PRODUZIONE ITALIANA

FOR YOUR PRACTICE ZERO COMPROMISES.

CLINIC AIR offers a phenomenal selection of compressed air products designed specifically for applications that require the absence of oil and that are sensitive to noise. The SMART and CLINIC SERIES consist of high-performance, oil-free, piston compressors. Along with the SW SERIES of surgical suctions, they are heavily demanded in dental and medical practices where clean air is critical for the safety and comfort of the patient. The SCROLL SERIES (spiral compression technology) thanks to its IE3 motors and a nominal power range of 2,2 to 7,5 kW opens a new world of functionalities in food and beverage, pharmaceutical, and medical centers. Lastly, the DECO SERIES are environmental disinfecting devices that produce a sophisticated ultra-dry, nebulization effect. They are used to guarantee a safe and effective treatment on a variety of surfaces and space where it is essential to have portable usage as well as automatic operation that does not require the presence of the user.

PER LA TUA ATTIVITÀ ZERO COMPROMESSI.

CLINIC AIR offre un'eccezionale offerta di prodotti per l'aria compressa, disegnati specificamente per applicazioni che richiedono aria priva di oli lubrificanti, e funzionalità a basso rumore. Le serie di compressori a secco ad alte prestazioni SMART e CLINIC, unite alla gamma di aspirazioni chirurgiche SW, sono prodotti altamente richiesti nei settori dentale e medicale dove poter contare su di un flusso di aria pura è un fattore critico per la sicurezza ed il comfort dei pazienti. La serie SCROLL (con tecnologia di compressione a spirale) grazie ai motori IE3 e ad una gamma che va dai 2,2 ai 7,5 kW apre un nuovo approccio di funzionalità, efficienza energetica e prestazioni nei settori alimentare, farmaceutico e ospedaliero. A completamento dell'offerta la serie DECO, dispositivi di sanificazione ambientale che, grazie alla sofisticata nebulizzazione ultra-dry, garantiscono un efficiente e sicuro trattamento di disinfezione in una vasta varietà di ambienti e superfici. La grande portabilità ed il funzionamento sia manuale che automatico (senza la presenza di operatore) rendono i dispositivi DECO adatti a tutte le esigenze.



technology video

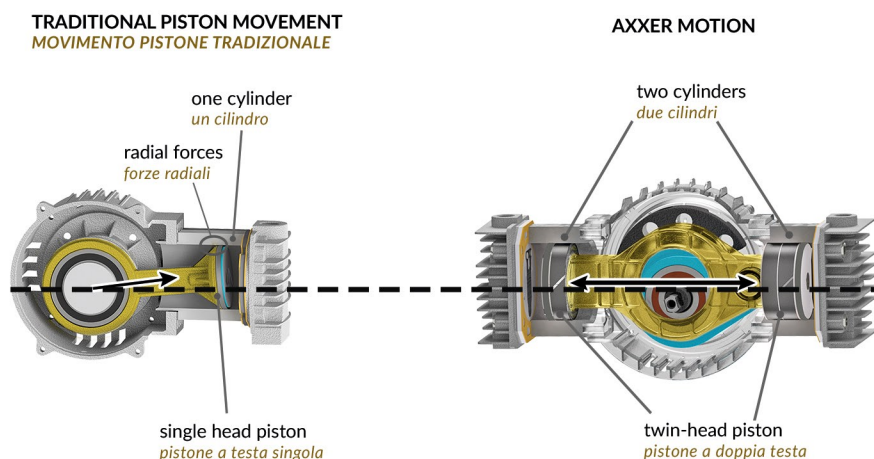

OIL-FREE PISTON COMPRESSORS COMPRESSORI A PISTONI A SECCO

SMART SERIES

	SMART SERIES	CLINIC SERIES	SCROLL SERIES
Oil-free: Class 0 / pure air <i>A secco: Classe 0 / aria pura</i>	✓	✓	✓
Quiet operation <i>Funzionamento silenzioso</i>	✓	✓	✓
Nonstop operation @ 10 bars <i>Operatività continua @ 10 bar</i>		✓	✓
Medical grade air <i>Aria di grado medicale</i>		✓	✓
High-efficiency IE3 motors <i>Motori IE3 ad alta efficienza</i>			✓



SMART 1.25

Without dryer
Senza essiccatore

SMART DRY 1.25

With adsorption dryer
Con essiccatore ad adsorbimento



0,75 kW (1,00 hp)

85 L/min @ 5 bars
85 L/min @ 5 bar

Ultra-quiet 60 dB(A)
Ultra-silenzioso 60 dB(A)

- ▶ Oil-free: Class 0
A secco: Classe 0
- ▶ Maximum pressure 8 bars
Pressione massima 8 bar

- ▶ Adsorption dryer
Essiccatore ad adsorbimento
- ▶ Steel tank, epoxy coating (internal/external)
Serbatoio in acciaio, verniciatura epossidica (interno/esterno)

	SMART 1.25	SMART DRY 1.25	
Users <i>Postazioni</i>	1	1	
Dryer dew point <i>Essiccatore punto rugiada</i>	-	Adsorption -20°C <i>Ad assorbimento -20°C</i>	
Sterilizing filter, µm <i>Filtro antibatterico, µm</i>	-	-	
Tank automatic drain <i>Scaricatore automatico serbatoio</i>	Optional	Optional	
Integrated hour meter <i>Contaore integrato</i>	Optional	Optional	
Solenoid valve <i>Valvola solenoide</i>	-	Included <i>Inclusa</i>	
Soundproofing cabinet dB(A) <i>Mobile insonorizzante dB(A)</i>	MOB/CMF24 -12	MOB/CMF24 -12	
V - Hz	230 - 50	230 - 50	
kW (hp)	0,75 (1,00)	0,75 (1,00)	
rpm	1400	1400	
Nominal current, A <i>Consumo, A</i>	4	4	
Cylinders <i>Cilindri</i>	2	2	
L/min @ 5 bars	85	85	
Max pressure, bars <i>Pressione max, bar</i>	8	8	
Duty cycle <i>Ciclo di lavoro</i>	S3 - 70%	S3 - 70%	
Tank, lt. <i>Serbatoio, lt.</i>	24	24	
dB(A)	60	60	
L x W x H cm	product <i>prodotto</i>	42 x 42 x 55 24 kg 1 pc	47 x 42 x 82 32 kg 1 pc
	package <i>Imballo</i>	57 x 68 x 95 39 kg 1 pc	57 x 68 x 95 47 kg 1 pc
	full pallet	114 x 68 x 190 176 kg 4 pc	114 x 68 x 190 208 kg 4 pc

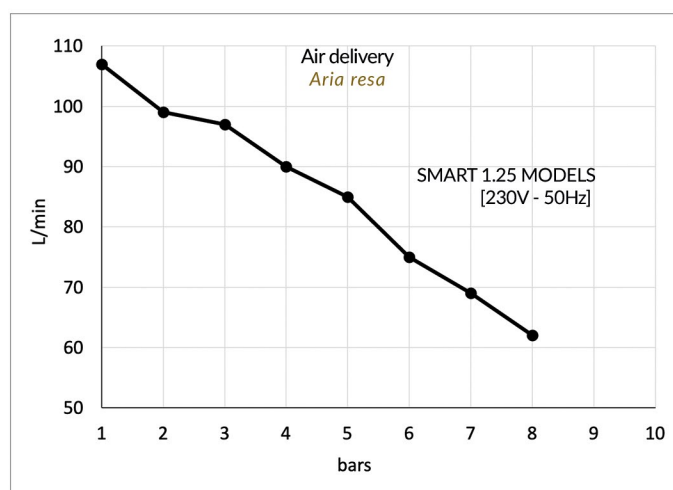

SMART 2.25

Without dryer
Senza essiccatore

SMART DRY 2.25

With adsorption dryer
Con essiccatore ad adsorbimento



1,50 kW (2,00 hp)

140 L/min @ 5 bars
140 L/min @ 5 bar

Ultra-quiet 65 dB(A)
Ultra-silenzioso 65 dB(A)

▶ Oil-free: Class 0
A secco: Classe 0

▶ Maximum pressure 8 bars
Pressione massima 8 bar

▶ Adsorption dryer
Essiccatore ad adsorbimento

▶ Steel tank, epoxy coating (internal/external)
Serbatoio in acciaio, verniciatura epossidica (interno/esterno)

	SMART 2.25	SMART DRY 2.25	
Users <i>Postazioni</i>	2	2	
Dryer dew point <i>Essiccatore punto rugiada</i>	-	Adsorption -20°C <i>Ad assorbimento -20°C</i>	
Sterilizing filter, µm <i>Filtro antibatterico, µm</i>	-	-	
Tank automatic drain <i>Scaricatore automatico serbatoio</i>	Optional	Optional	
Integrated hour meter <i>Contaore integrato</i>	Optional	Optional	
Solenoid valve <i>Valvola solenoide</i>	-	Included <i>Inclusa</i>	
Soundproofing cabinet dB(A) <i>Mobile insonorizzante dB(A)</i>	MOB/CMF24 -12	MOB/CMF24 -12	
V - Hz	230 - 50	230 - 50	
kW (hp)	1,50 (2,00)	1,50 (2,00)	
rpm	1400	1400	
Nominal current, A <i>Consumo, A</i>	7	7	
Cylinders <i>Cilindri</i>	2	2	
L/min @ 5 bars	140	140	
Max pressure, bars <i>Pressione max, bar</i>	8	8	
Duty cycle <i>Ciclo di lavoro</i>	S3 - 70%	S3 - 70%	
Tank, lt. <i>Serbatoio, lt.</i>	24	24	
dB(A)	65	65	
L x W x H cm	product <i>prodotto</i>	42 x 42 x 63 32 kg 1 pc	47 x 42 x 82 40 kg 1 pc
	package <i>Imballo</i>	57 x 68 x 95 45 kg 1 pc	57 x 68 x 95 52 kg 1 pc
	full pallet	114 x 68 x 190 200 kg 4 pc	114 x 68 x 190 228 kg 4 pc



SMART 4.90

Without dryer
Senza essiccatore

SMART DRY 4.90

With adsorption dryer
Con essiccatore ad adsorbimento



3,00 kW (4,00 hp)

280 L/min @ 5 bars
280 L/min @ 5 bar

Ultra-quiet 68 dB(A)
Ultra-silenzioso 68 dB(A)

- ▶ Oil-free: Class 0
A secco: Classe 0
- ▶ Maximum pressure 8 bars
Pressione massima 8 bar

- ▶ Adsorption dryer
Essiccatore ad adsorbimento
- ▶ Steel tank, epoxy coating (internal/external)
Serbatoio in acciaio, verniciatura epossidica (interno/esterno)

	SMART 4.90	SMART DRY 4.90	
Users <i>Postazioni</i>	4	4	
Dryer dew point <i>Essiccatore punto rugiada</i>	-	Adsorption -20°C <i>Ad assorbimento -20°C</i>	
Sterilizing filter, µm <i>Filtro antibatterico, µm</i>	-	-	
Tank automatic drain <i>Scaricatore automatico serbatoio</i>	Optional	Optional	
Integrated hour meter <i>Contaore integrato</i>	Optional	Optional	
Solenoid valve <i>Valvola solenoide</i>	-	Included <i>Inclusa</i>	
Soundproofing cabinet dB(A) <i>Mobile insonorizzante dB(A)</i>	MOB/CMF90/1 -12	MOB/CMF90/1 -12	
V - Hz	230 - 50	230 - 50	
kW (hp)	3,00 (4,00)	3,00 (4,00)	
rpm	1400	1400	
Nominal current, A <i>Consumo, A</i>	7 + 7	7 + 7	
Cylinders <i>Cilindri</i>	4	4	
L/min @ 5 bars	280	280	
Max pressure, bars <i>Pressione max, bar</i>	8	8	
Duty cycle <i>Ciclo di lavoro</i>	53 - 70%	53 - 70%	
Tank, lt. <i>Serbatoio, lt.</i>	90	90	
dB(A)	68	68	
L x W x H cm	product <i>prodotto</i>	99 x 39 x 76 78 kg	99 x 53 x 83 86 kg
	package <i>Imballo</i>	110 x 60 x 97 98 kg	110 x 60 x 97 106 kg
	full pallet	-	-

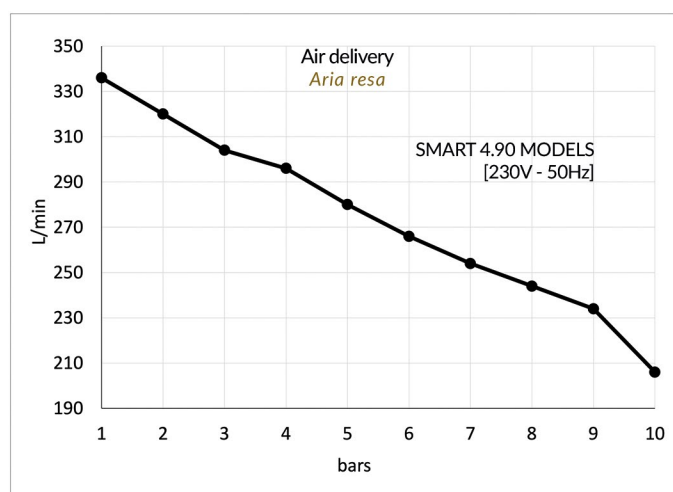

SMART 1.25-S

Without dryer
Senza essiccatore

SMART DRY 1.25-S

With adsorption dryer
Con essiccatore ad adsorbimento



0,75 kW (1,00 hp)

72 L/min @ 5 bars
72 L/min @ 5 bar

Ultra-quiet 62 dB(A)
Ultra-silenzioso 62 dB(A)

- ▶ Oil-free: Class 0
A secco: Classe 0
- ▶ Solenoid depressurizing valve
Valvola solenoide di depressurizzazione
- ▶ Adsorption dryer
Essiccatore ad adsorbimento
- ▶ Maximum pressure 8 bars
Pressione massima 8 bar
- ▶ Steel tank, epoxy coating (internal/external)
Serbatoio in acciaio, verniciatura epossidica (interno/esterno)

	SMART 1.25-S	SMART DRY 1.25-S	
Users <i>Postazioni</i>	1	1	
Dryer dew point <i>Essiccatore punto rugiada</i>	-	Adsorption -20°C <i>Ad assorbimento -20°C</i>	
Sterilizing filter, µm <i>Filtro antibatterico, µm</i>	-	-	
Tank automatic drain <i>Scaricatore automatico serbatoio</i>	Optional	Optional	
Integrated hour meter <i>Contaore integrato</i>	Optional	Optional	
Solenoid valve <i>Valvola solenoide</i>	Included <i>Inclusa</i>	Included <i>Inclusa</i>	
Soundproofing cabinet dB(A) <i>Mobile insonorizzante dB(A)</i>	MOB/CMF24 -12	MOB/CMF24 -12	
V - Hz	230 - 50	230 - 50	
kW (hp)	0,75 (1,00)	0,75 (1,00)	
rpm	1400	1400	
Nominal current, A <i>Consumo, A</i>	4,5	4,5	
Cylinders <i>Cilindri</i>	1	1	
L/min @ 5 bars	72	72	
Max pressure, bars <i>Pressione max, bar</i>	8	8	
Duty cycle <i>Ciclo di lavoro</i>	S3 - 70%	S3 - 70%	
Tank, lt. <i>Serbatoio, lt.</i>	24	24	
dB(A)	62	62	
L x W x H cm	product <i>prodotto</i>	42 x 42 x 70 31 kg 1 pc	46 x 42 x 81 39 kg 1 pc
	package <i>Imballo</i>	57 x 68 x 95 33 kg 1 pc	57 x 68 x 95 38 kg 1 pc
	full pallet	114 x 68 x 190 152 kg 4 pc	114 x 68 x 190 172 kg 4 pc

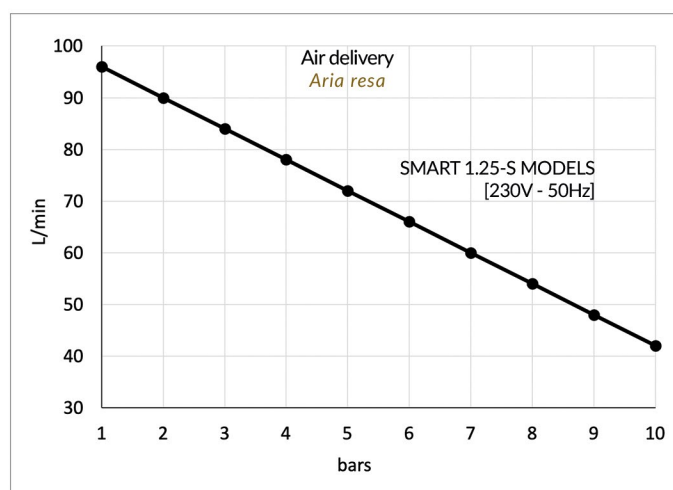

SMART 3.25-S

Without dryer
Senza essiccatore

SMART DRY 3.25-S

With adsorption dryer
Con essiccatore ad adsorbimento

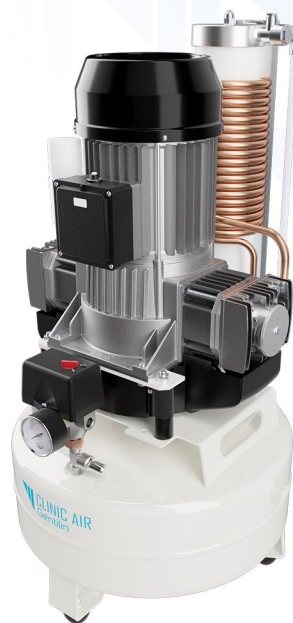

1,80 kW (2,40 hp)

155 L/min @ 5 bars
155 L/min @ 5 bar

Ultra-quiet 67 dB(A)
Ultra-silenzioso 67 dB(A)

▶ Oil-free: Class 0
A secco: Classe 0

▶ Solenoid depressurizing valve
Valvola solenoide di depressurizzazione

▶ Adsorption dryer
Essiccatore ad adsorbimento

▶ Maximum pressure 10 bars
Pressione massima 10 bar

▶ Steel tank, epoxy coating (internal/external)
Serbatoio in acciaio, verniciatura epossidica (interno/esterno)

	SMART 3.25-S	SMART DRY 3.25-S	
Users <i>Postazioni</i>	2 + 1	2 + 1	
Dryer dew point <i>Essiccatore punto rugiada</i>	-	Adsorption -20°C <i>Ad assorbimento -20°C</i>	
Sterilizing filter, µm <i>Filtro antibatterico, µm</i>	-	-	
Tank automatic drain <i>Scaricatore automatico serbatoio</i>	Optional	Optional	
Integrated hour meter <i>Contaore integrato</i>	Optional	Optional	
Solenoid valve <i>Valvola solenoide</i>	Included <i>Inclusa</i>	Included <i>Inclusa</i>	
Soundproofing cabinet dB(A) <i>Mobile insonorizzante dB(A)</i>	MOB/CMF24 -12	MOB/CMF24 -12	
V - Hz	230 - 50	230 - 50	
kW (hp)	1,80 (2,40)	1,80 (2,40)	
rpm	1400	1400	
Nominal current, A <i>Consumo, A</i>	8,5	8,5	
Cylinders <i>Cilindri</i>	2	2	
L/min @ 5 bars	155	155	
Max pressure, bars <i>Pressione max, bar</i>	10	10	
Duty cycle <i>Ciclo di lavoro</i>	S1 - 100%	S1 - 100%	
Tank, lt. <i>Serbatoio, lt.</i>	24	24	
dB(A)	67	67	
L x W x H cm	product <i>prodotto</i>	42 x 42 x 74 36 kg 1 pc	42 x 50 x 83 43 kg 1 pc
	package <i>Imballo</i>	57 x 68 x 95 40 kg 1 pc	57 x 68 x 95 45 kg 1 pc
	full pallet	114 x 68 x 190 180 kg 4 pc	114 x 68 x 190 200 kg 4 pc

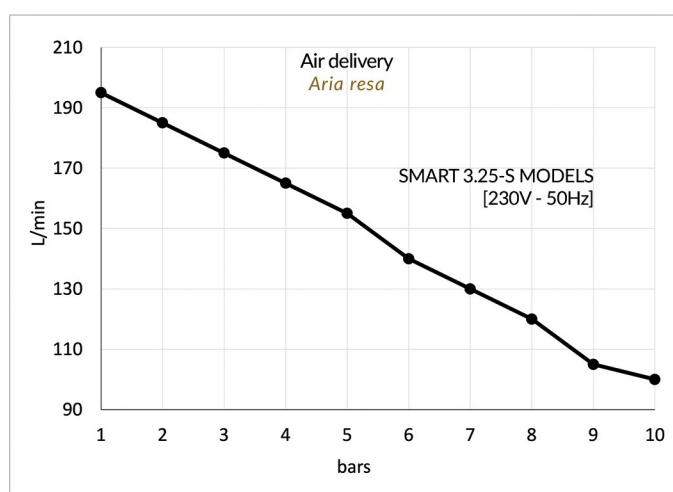

OIL-FREE PISTON COMPRESSORS COMPRESSORI A PISTONI A SECCO

CLINIC SERIES

	SMART SERIES	CLINIC SERIES	SCROLL SERIES
Oil-free: Class 0 / pure air <i>A secco: Classe 0 / aria pura</i>	✓	✓	✓
Quiet operation <i>Funzionamento silenzioso</i>	✓	✓	✓
Nonstop operation @ 10 bars <i>Operatività continua @ 10 bar</i>		✓	✓
Medical grade air <i>Aria di grado medicale</i>		✓	✓
High-efficiency IE3 motors <i>Motori IE3 ad alta efficienza</i>			✓



CLINIC 3.40

Without dryer
Senza essiccatore

CAD/CAM APPROVED

CLINIC DRY 3.40 H

With membrane dryer
Con essiccatore a membrana

CLINIC DRY 3.40 HS

With membrane dryer and sterilization filter
Con essiccatore a membrana e filtro antibatterico

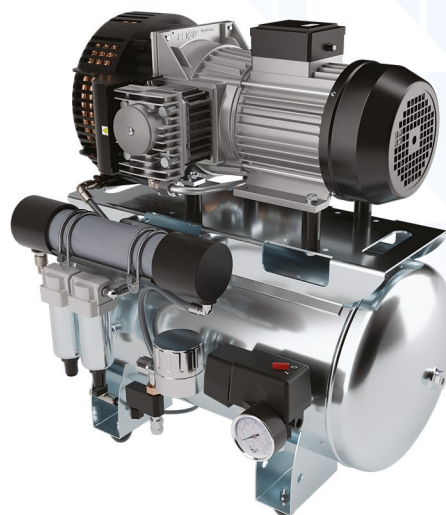

1,80 kW (2,40 hp)

Up to 155 L/min @ 5 bars
Fino a 155 L/min @ 5 bar

Ultra-quiet 67 dB(A)
Ultra-silenzioso 67 dB(A)

- ▶ Oil-free: Class 0
A secco: Classe 0
- ▶ Energy-saving motor
Motore a risparmio energetico
- ▶ Hour meter
Contaore
- ▶ Solenoid depressurizing valve
Valvola solenoide di depressurizzazione
- ▶ Stainless steel AISI 304 tank
Serbatoio in acciaio inox AISI 304
- ▶ Nonstop operation at 10 bars
Operatività continua a 10 bar
- ▶ Automatic tank drain
Scaricatore automatico serbatoio
- ▶ Continuous cycle membrane drying
Essiccazione a membrana a ciclo continuo
- ▶ Sterilizing filter
Filtro antibatterico
- ▶ No maintenance up to 3000 hours *
Nessuna manutenzione fino a 3000 ore

* 10 bars continuous operation at 40°C
Funzionamento in continuo a 10 bar a 40°C

	CLINIC 3.40	CLINIC DRY 3.40 H	CLINIC DRY 3.40 HS	
Users <i>Postazioni</i>	2 + 1	2	2	
Dryer dew point <i>Essiccatore punto rugiada</i>	-	Membrane -40°C <i>A membrana -40°C</i>	Membrane -40°C <i>A membrana -40°C</i>	
Sterilizing filter μm <i>Filtro antibatterico μm</i>	-	-	0,01	
Tank automatic drain <i>Scaricatore automatico serbatoio</i>	Included <i>Incluso</i>	Optional	Optional	
Hour Meter <i>Contaore</i>	Included <i>Incluso</i>	Included <i>Incluso</i>	Included <i>Incluso</i>	
Solenoid valve <i>Valvola solenoide</i>	Included <i>Inclusa</i>	Included <i>Inclusa</i>	Included <i>Inclusa</i>	
Soundproofing cabinet dB(A) <i>Mobile insonorizzante dB(A)</i>	MOB/CMF40 -12	MOB/CMF40 -12	MOB/CMF40 -12	
V - Hz	230 - 50	230 - 50	230 - 50	
kW (hp)	1,80 (2,40)	1,80 (2,40)	1,80 (2,40)	
rpm	1400	1400	1400	
Nominal current, A <i>Consumo, A</i>	8,5	8,5	8,5	
Cylinders <i>Cilindri</i>	2	2	2	
L/min @ 5 bars	155	135	135	
Max pressure, bars <i>Pressione max, bar</i>	10	10	10	
Duty cycle <i>Ciclo di lavoro</i>	S1 - 100%	S1 - 100%	S1 - 100%	
Tank, lt. <i>Serbatoio, lt.</i>	40	40	40	
dB(A)	67	67	67	
L x W x H cm	product <i>prodotto</i>	65 x 46 x 65 39 kg 1 pc	65 x 46 x 66 42 kg 1 pc	65 x 46 x 66 42 kg 1 pc
	package <i>Imballo</i>	57 x 68 x 95 42 kg 1 pc	57 x 68 x 95 43 kg 1 pc	57 x 68 x 95 43 kg 1 pc
	full pallet	114 x 68 x 190 168 kg 4 pc	114 x 68 x 190 172 kg 4 pc	114 x 68 x 190 172 kg 4 pc

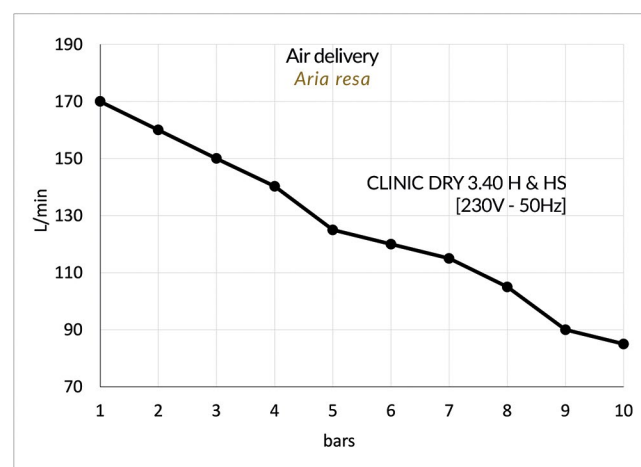
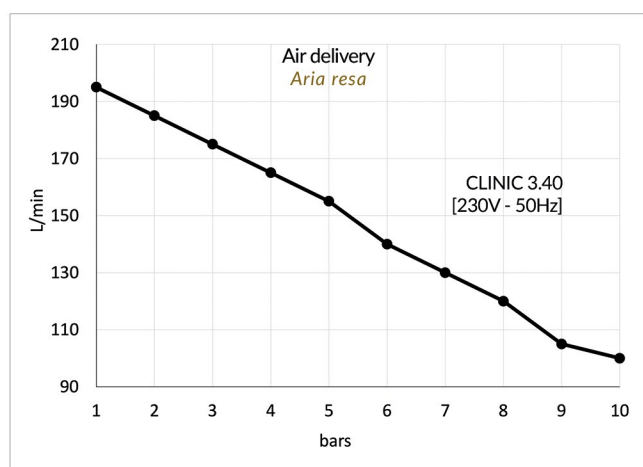

CLINIC 6.90

Without dryer
Senza essiccatore

CAD/CAM APPROVED

CLINIC DRY 6.90 H

With membrane dryer
Con essiccatore a membrana

CLINIC DRY 6.90 HS

With membrane dryer and sterilization filter
Con essiccatore a membrana e filtro antibatterico

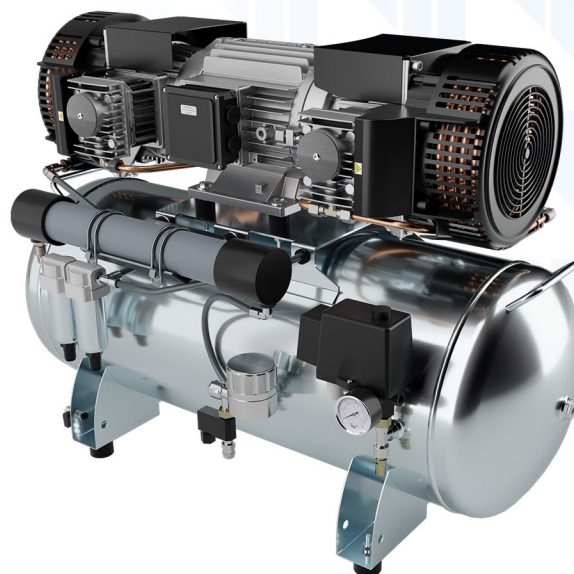

Up to 3,00 kW (4,00 hp)
Fino a 3,00 kW (4,00 hp)

Up to 310 L/min @ 5 bars
Fino a 310 L/min @ 5 bar

Ultra-quiet 72 - 74 dB(A)
Ultra-silenzioso 72 - 74 dB(A)

- ▶ Oil-free: Class 0
A secco: Classe 0
- ▶ Energy-saving motor
Motore a risparmio energetico
- ▶ Hour meter
Contaore
- ▶ Solenoid depressurizing valve
Valvola solenoide di depressurizzazione
- ▶ Stainless steel AISI 304 tank
Serbatoio in acciaio inox AISI 304
- ▶ Nonstop operation at 10 bars
Operatività continua a 10 bar
- ▶ Automatic tank drain
Scaricatore automatico serbatoio
- ▶ Continuous cycle membrane drying
Essiccazione a membrana a ciclo continuo
- ▶ Sterilizing filter
Filtro antibatterico
- ▶ No maintenance up to 3000 hours *
Nessuna manutenzione fino a 3000 ore

* 10 bars continuous operation at 40°C
Funzionamento in continuo a 10 bar a 40°C

	CLINIC 6.90		CLINIC DRY 6.90 H		CLINIC DRY 6.90 HS	
Users <i>Postazioni</i>	4 + 1 [230V]	5 + 1 [400V]	4 + 1 [230V]	5 + 1 [400V]	4 + 1 [230V]	5 + 1 [400V]
Dryer dew point <i>Essiccatore punto rugiada</i>	-	-	Membrane -40°C <i>A membrana -40°C</i>	Membrane -40°C <i>A membrana -40°C</i>	Membrane -40°C <i>A membrana -40°C</i>	Membrane -40°C <i>A membrana -40°C</i>
Sterilizing filter, µm <i>Filtro antibatterico, µm</i>	-	-	-	-	0,01	0,01
Tank automatic drain <i>Scaricatore automatico serbatoio</i>	Included <i>Incluso</i>	Included <i>Incluso</i>	Optional	Optional	Optional	Optional
Hour Meter <i>Contaore</i>	Included <i>Incluso</i>	Included <i>Incluso</i>	Included <i>Incluso</i>	Included <i>Incluso</i>	Included <i>Incluso</i>	Included <i>Incluso</i>
Solenoid valve <i>Valvola solenoide</i>	Included <i>Inclusa</i>	Included <i>Inclusa</i>	Included <i>Inclusa</i>	Included <i>Inclusa</i>	Included <i>Inclusa</i>	Included <i>Inclusa</i>
Soundproofing cabinet dB(A) <i>Mobile insonorizzante dB(A)</i>	-12	-12	-12	-12	-12	-12
MOB/CMF90/X	/1	/2	/1	/2	/1	/2
V - Hz	230 - 50	400 - 50	230 - 50	400 - 50	230 - 50	400 - 50
kW (hp)	2,80 (3,75)	3,00 (4,20)	2,80 (3,75)	3,00 (4,00)	2,80 (3,75)	3,00 (4,00)
rpm	1400	1400	1400	1400	1400	1400
Nominal current, A <i>Consumo, A</i>	14	6,5	14	6,5	14	6,5
Cylinders <i>Cilindri</i>	4	4	4	4	4	4
L/min @ 5 bars	260	310	235	265	235	265
Max pressure, bars <i>Pressione max, bar</i>	10	10	10	10	10	10
Duty cycle <i>Ciclo di lavoro</i>	S1 - 100%	S1 - 100%	S1 - 100%	S1 - 100%	S1 - 100%	S1 - 100%
Tank, lt. <i>Serbatoio, lt.</i>	90	90	90	90	90	90
dB(A)	72	74	72	74	72	74
L x W x H cm	product <i>prodotto</i>	99 x 49 x 71 82 kg	99 x 49 x 71 86 kg	99 x 49 x 71 86 kg	99 x 49 x 71 86 kg	99 x 49 x 71 86 kg
	package <i>imballo</i>	60 x 110 x 90 100 kg	60 x 110 x 90 105 kg	60 x 110 x 90 105 kg	60 x 110 x 90 105 kg	60 x 110 x 90 105 kg
	full pallet	-	-	-	-	-

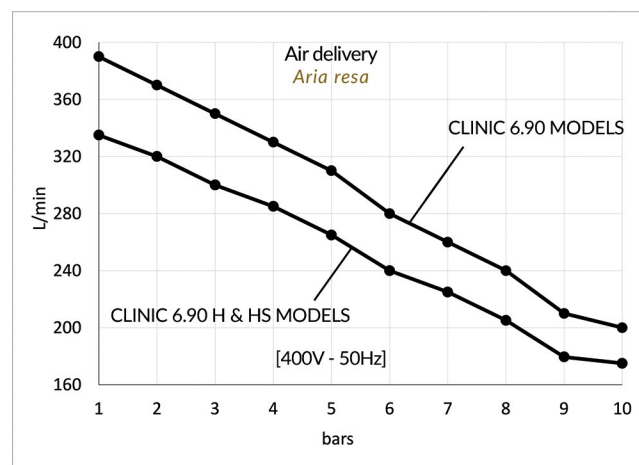
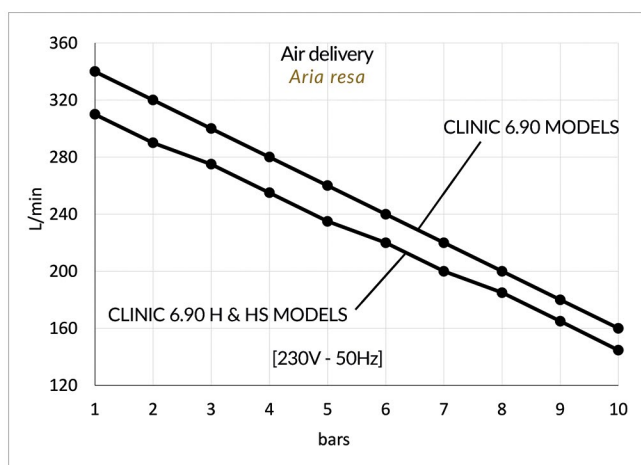

CLINIC 12.500

Without dryer
Senza essiccatore

CAD/CAM APPROVED

CLINIC DRY 12.500 H

With membrane dryer
Con essiccatore a membrana

CLINIC DRY 12.500 HS

With membrane dryer and sterilization filter
Con essiccatore a membrana e filtro antibatterico

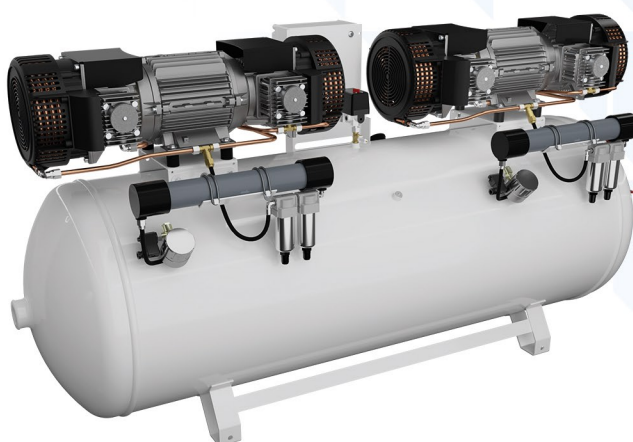

6,00 kW (8,00 hp)

Up to 620 L/min @ 5 bars
Fino a 620 L/min @ 5 bar

Ultra-quiet 78 dB(A)
Ultra-silenzioso 78 dB(A)

- ▶ Oil-free: Class 0
A secco: Classe 0
 - ▶ Energy-saving motor
Motore a risparmio energetico
 - ▶ Hour meter
Contaore
 - ▶ Solenoid depressurizing valve
Valvola solenoide di depressurizzazione
 - ▶ Steel tank, epoxy coating (internal/external)
Serbatoio in acciaio, verniciatura epossidica (interno/esterno)
 - ▶ Nonstop operation at 10 bars
Operatività continua a 10 bar
 - ▶ Adjustment for smooth air-ends operation
Controllo per funzionamento omogeneo pompanti
 - ▶ Switch for single/in tandem operation
Interruttore azionamento singolo/in tandem
 - ▶ Automatic tank drain
Scaricatore automatico serbatoio
 - ▶ Continuous cycle membrane drying
Essiccazione a membrana a ciclo continuo
 - ▶ Sterilizing filter
Filtro antibatterico
 - ▶ No maintenance up to 3000 hours *
Nessuna manutenzione fino a 3000 ore
- * 10 bars continuous operation at 40°C
Funzionamento in continuo a 10 bar a 40°C

	CLINIC 12.500	CLINIC DRY 12.500 H	CLINIC DRY 12.500 HS
Users <i>Postazioni</i>	10 + 2	9 + 1	9 + 1
Dryer dew point <i>Essiccatore punto rugiada</i>	-	Membrane -40°C <i>A membrana -40°C</i>	Membrane -40°C <i>A membrana -40°C</i>
Sterilizing filter, µm <i>Filtro antibatterico, µm</i>	-	-	0,01
Tank automatic drain <i>Scaricatore automatico serbatoio</i>	Included <i>Incluso</i>	Optional	Optional
Hour Meter <i>Contaore</i>	Included <i>Incluso</i>	Included <i>Incluso</i>	Included <i>Incluso</i>
Solenoid valve <i>Valvola solenoide</i>	Included <i>Inclusa</i>	Included <i>Inclusa</i>	Included <i>Inclusa</i>
Soundproofing cabinet dB(A) <i>Mobile insonorizzante dB(A)</i>	-	-	-
V - Hz	400 - 50	400 - 50	400 - 50
kW (hp)	6,00 (8,00)	6,00 (8,00)	6,00 (8,00)
rpm	1400	1400	1400
Nominal current, A <i>Consumo, A</i>	6,5 + 6,5	6,5 + 6,5	6,5 + 6,5
Cylinders <i>Cilindri</i>	8	8	8
L/min @ 5 bars	620	530	530
Max pressure, bars <i>Pressione max, bar</i>	10	10	10
Duty cycle <i>Ciclo di lavoro</i>	S1 - 100%	S1 - 100%	S1 - 100%
Tank, lt. <i>Serbatoio, lt.</i>	500	500	500
dB(A)	78	78	78
L x W x H cm	product <i>prodotto</i>	204 x 67 x 98 340 kg	204 x 70 x 98 346 kg
	package <i>Imballo</i>	210 x 77 x 114 385 kg	210 x 77 x 114 391 kg
	full pallet	-	-

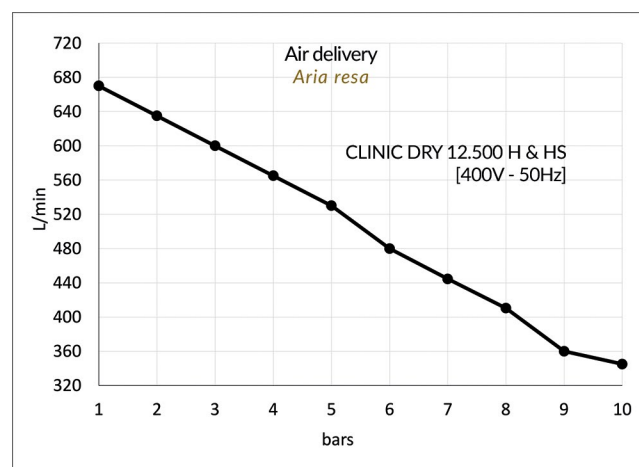
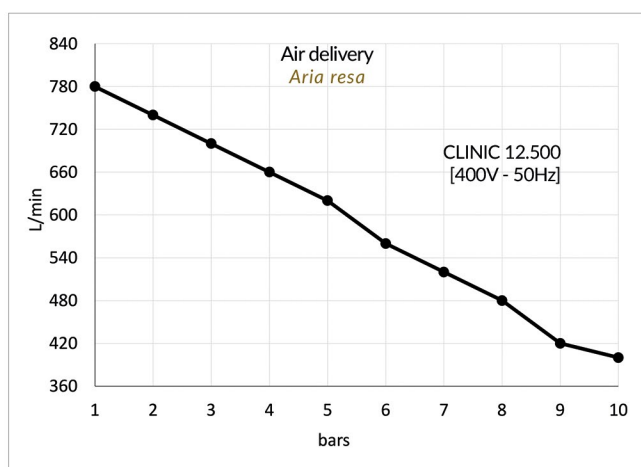

SOUNDPROOFING CABINETS FOR PISTON COMPRESSORS

MOBILI INSONORIZZANTI PER COMPRESSORI A PISTONI

MOB/CMF SERIES



MOB/CMF24

For 24 lt. piston compressors
Per compressori a pistoni di 24 lt.

MOB/CMF40

For 40 lt. piston compressors
Per compressori a pistoni di 40 lt.

MOB/CMF90

For 90 lt. piston compressors
Per compressori a pistoni di 90 lt.



- ▶ Optimized space-saving design for tight corners and small offices
Design compatto ottimizzato per spazi stretti e angusti
- ▶ Sturdy metal construction for extended use
Struttura in metallo, resistente e duratura
- ▶ Internal sound-dampening polyurethane walls to reduce noise
Rivestimento interno in poliuretano fonoassorbente
- ▶ Thermostat-controlled extractor fans
Ventole di estrazione calore regolate da termostato
- ▶ Pre-assembled, easy to install and position in place
Pre-assemblato, facile da mettere in opera
- ▶ External ON/OFF switch
Comandi ON/OFF esterni
- ▶ Autonomous power cable
Cavo di alimentazione autonomo
- ▶ Noise reduction -12 dB(A)
Riduzione del rumore -12 dB(A)

84209

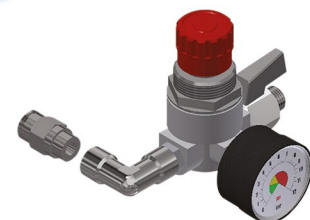

Optional: External pressure regulator
Optional: Kit controllo pressione esterno

COMPRESSORS <i>COMPRESSORI</i>	V - Hz	CABINETS <i>MOBILI</i>
SMART 1.25	230 - 50	MOB/CMF24
SMART DRY 1.25	230 - 50	MOB/CMF24
SMART 2.25	230 - 50	MOB/CMF24
SMART DRY 2.25	230 - 50	MOB/CMF24
SMART 4.90	230 - 50	MOB/CMF90/1
SMART DRY 4.90	230 - 50	MOB/CMF90/1
SMART 1.25-S	230 - 50	MOB/CMF24
SMART DRY 1.25-S	230 - 50	MOB/CMF24
SMART 3.25-S	230 - 50	MOB/CMF24
SMART DRY 3.25-S	230 - 50	MOB/CMF24
CLINIC 3.40	230 - 50	MOB/CMF40
CLINIC DRY 3.40 H	230 - 50	MOB/CMF40
CLINIC DRY 3.40 HS	230 - 50	MOB/CMF40
CLINIC 6.90	230 - 50	MOB/CMF90/1
CLINIC 6.90	400 - 50	MOB/CMF90/2
CLINIC DRY 6.90 H	230 - 50	MOB/CMF90/1
CLINIC DRY 6.90 H	400 - 50	MOB/CMF90/2
CLINIC DRY 6.90 HS	230 - 50	MOB/CMF90/1
CLINIC DRY 6.90 HS	400 - 50	MOB/CMF90/2

		MOB/CMF24	MOB/CMF40	MOB/CMF90/1	MOB/CMF90/2
L x W x H cm	product <i>prodotto</i>	62 x 62 x 88 26 kg	82 x 56 x 71 26 kg	82 x 56 x 71 26 kg	82 x 56 x 71 26 kg
	package <i>imballo</i>	80 x 31 x 91 36 kg	80 x 31 x 91 36 kg	125 x 40 x 105 55 kg	125 x 40 x 105 55 kg
	full pallet				

OIL-FREE SCROLL COMPRESSORS COMPRESSORI SCROLL A SECCO

SCROLL SERIES

	SMART SERIES	CLINIC SERIES	SCROLL SERIES
Oil-free: Class 0 / pure air <i>A secco: Classe 0 / aria pura</i>	✓	✓	✓
Quiet operation <i>Funzionamento silenzioso</i>	✓	✓	✓
Nonstop operation @ 10 bars <i>Operatività continua @ 10 bar</i>		✓	✓
Medical grade air <i>Aria di grado medicale</i>		✓	✓
High-efficiency IE3 motors <i>Motori IE3 ad alta efficienza</i>			✓



SCROLL SCA

Without dryer
Senza essiccatore

SCROLL SCR

With refrigerated dryer
Con essiccatore frigorifero



Up to 7,5 kW (10,0 hp)
Fino a 7,5 kW (10,0 hp)

Up to 850 L/min @ 8 bars
Fino a 850 L/min @ 8 bar

Ultra-quiet 64 - 67 dB(A)
Ultra-silenzioso 64 - 67 dB(A)

- ▶ Oil-free: Class 0
A secco: Classe 0
- ▶ A&G high-efficiency motors (IE3)
Motori elettrici ad alta efficienza A&G (IE3)
- ▶ Steel tank: external epoxy coating and internal Teflon coating.
Serbatoio in acciaio: verniciatura epossidica (interno) e teflonatura (esterno).
- ▶ Refrigerated dryer
Essiccatore frigorifero
- ▶ Nonstop operation at 10 bars
Operatività continua a 10 bar
- ▶ Noise-reducing cabinet
Mobile insonorizzante
- ▶ No maintenance up to 8000 hours *
Nessuna manutenzione fino a 8000 ore
- ▶ Programmable logic controller (PLC)
Centralina di controllo elettronica (PLC)
- ▶ Siemens electronic components
Componenti elettronici Siemens
- ▶ Hitachi mechanics
Meccanica Hitachi

			kW / hp	V - Hz	rpm	L/min @ 8 bars	db(A)	product prodotto		package imballo	
								L x W x H cm	kg	L x W x H cm	
without tank senza serbatoio	A	SCA300/S	2,2 (3,0)	230 - 50	3250	240	64	65 x 57 x 86	128	65 x 57 x 106	
		SCA300/T	2,2 (3,0)	400 - 50	3250	240	64	65 x 57 x 86	128	65 x 57 x 106	
		SCA550/T	4,0 (5,5)	400 - 50	2200	410	67	75 x 60 x 96	140	75 x 60 x 116	
	B	SCR300/S	2,2 (3,0)	230 - 50	3250	240	64	84 x 57 x 86	158	84 x 57 x 106	
		SCR300/T	2,2 (3,0)	400 - 50	3250	240	64	84 x 57 x 86	158	84 x 57 x 106	
		SCR550/T	4,0 (5,5)	400 - 50	2200	410	67	101 x 60 x 96	190	101 x 60 x 116	
	C	SCA300/SP	2,2 (3,0)	230 - 50	3250	240	64	65 x 57 x 86	128	65 x 57 x 106	
		SCA300/TP	2,2 (3,0)	400 - 50	3250	240	64	65 x 57 x 86	128	65 x 57 x 106	
		SCA550/TP	4,0 (5,5)	400 - 50	2200	410	67	75 x 60 x 96	140	75 x 60 x 116	
		SCA750/TP	5,5 (7,5)	400 - 50	3180	630	67	75 x 60 x 96	145	75 x 60 x 116	
	D	SCA1000/TP	7,5 (10,0)	400 - 50	3180	850	67	75 x 60 x 96	148	75 x 60 x 116	
		SCR300/SP	2,2 (3,0)	230 - 50	3250	240	64	84 x 57 x 86	158	84 x 57 x 106	
		SCR300/TP	2,2 (3,0)	400 - 50	3250	240	64	84 x 57 x 86	158	84 x 57 x 106	
		SCR550/TP	4,0 (5,5)	400 - 50	2200	410	67	101 x 60 x 96	190	101 x 60 x 116	
		SCR750/TP	5,5 (7,5)	400 - 50	3180	630	67	101 x 60 x 96	195	101 x 60 x 116	
with 270 lt. tank con serbatoio 270 lt.	A	SCR1000/TP	7,5 (10,0)	400 - 50	3180	850	67	101 x 60 x 96	198	101 x 60 x 116	
		SCA300/S-270	2,2 (3,0)	230 - 50	3250	240	64	119 x 61 x 148	198	119 x 61 x 168	
		SCA300/T-270	2,2 (3,0)	400 - 50	3250	240	64	119 x 61 x 148	198	119 x 61 x 168	
	B	SCA550/T-270	4,0 (5,5)	400 - 50	2200	410	67	119 x 61 x 158	215	119 x 61 x 178	
		SCR300/S-270	2,2 (3,0)	230 - 50	3250	240	64	118 x 61 x 147	228	118 x 61 x 167	
		SCR300/T-270	2,2 (3,0)	400 - 50	3250	240	64	118 x 61 x 147	228	118 x 61 x 167	
	C	SCR550/T-270	4,0 (5,5)	400 - 50	2200	410	67	118 x 61 x 157	265	118 x 61 x 177	
		SCA300/SP-270	2,2 (3,0)	230 - 50	3250	240	64	119 x 61 x 148	198	119 x 61 x 168	
		SCA300/TP-270	2,2 (3,0)	400 - 50	3250	240	64	119 x 61 x 148	198	119 x 61 x 168	
		SCA550/TP-270	4,0 (5,5)	400 - 50	2200	410	67	119 x 61 x 158	215	119 x 61 x 178	
		SCA750/TP-270	5,5 (7,5)	400 - 50	3180	630	67	119 x 61 x 158	220	119 x 61 x 178	
	D	SCA1000/TP-270	7,5 (10,0)	400 - 50	3180	850	67	119 x 61 x 158	223	119 x 61 x 178	
		SCR300/SP-270	2,2 (3,0)	230 - 50	3250	240	64	118 x 61 x 147	228	118 x 61 x 167	
		SCR300/TP-270	2,2 (3,0)	400 - 50	3250	240	64	118 x 61 x 147	228	118 x 61 x 167	
		SCR550/TP-270	4,0 (5,5)	400 - 50	2200	410	67	118 x 61 x 157	265	118 x 61 x 167	
SCR750/TP-270		5,5 (7,5)	400 - 50	3180	630	67	118 x 61 x 157	270	118 x 61 x 167		
		SCR1000/TP-270	7,5 (10,0)	400 - 50	3180	850	67	118 x 61 x 157	273	118 x 61 x 167	

A BASIC MODELS
MODELLI BASE

B BASIC MODELS WITH REFRIGERATED DRYER
MODELLI CON ESSICCATORE FRIGORIFERO

C PREMIUM MODELS WITH STAR/DELTA START + PLC
MODELLI PREMIUM CON AVVIAMENTO STELLA/TRIANGOLO + PLC

D PREMIUM MODELS WITH STAR/DELTA START + PLC + REFRIGERATED DRYER
MODELLI PREMIUM CON AVVIAMENTO STELLA/TRIANGOLO + PLC + ESSICCATORE FRIGORIFERO

SEMI-WET SUCTION SYSTEMS ASPIRAZIONI AD ANELLO UMIDO

SW SERIES

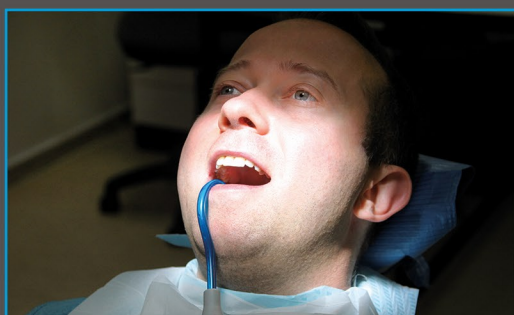

SW-S101

SW-M2000



Up to 1,10 kW (1,48 hp)
Fino a 1,10 kW (1,48 hp)

Up to 270 mbars
Fino a 270 mbar

Ultra-quiet 55 dB(A)
Ultra-silenzioso 55 dB(A)

- ▶ Energy-saving motor
Motore a risparmio energetico
- ▶ Does not require water supply
Non richiede approvvigionamento idrico
- ▶ Air/liquid separation unit
Separatore aria/liquido
- ▶ Automatic drain valve
Valvola di scarico automatica
- ▶ Can be fitted with amalgam separator
Integrabili con separatore di amalgama

AS02

AMALGAM SEPARATOR
SEPARATORE DI AMALGAMA



- ▶ 100% recyclable
100% riciclabile
- ▶ No power required
Nessuna connessione elettrica
- ▶ Does not require maintenance
Nessuna manutenzione richiesta
- ▶ Separation rate 96,6%
Livello di separazione 96,6%
- ▶ ISO 11143:2008

	SW-S101	SW-M2000	AS02	
Users <i>Postazioni</i>	1	2	-	
V - Hz	230 - 50/60	230 - 50/60	-	
kW (hp)	0,40 - 0,50 (0,54 - 0,67)	0,90 - 1,10 (1,21 - 1,48)	-	
Nominal current, A <i>Consumo, A</i>	2,7 - 3,2	6,2 - 7,4	-	
rpm	2900 - 3440	2900 - 3440	-	
Max vacuum, mbars <i>Vuoto max, mbar</i>	150 - 180	220 - 270	-	
Max liquid inlet, L/min <i>Entrata liquido massima, L/min</i>	11 - 13	11 - 13	-	
Suction inlet (internal hose), mm <i>Entrata aspirazione (tubo interno), mm</i>	38	38	-	
Waste outlet (internal hose), mm <i>Uscita rifiuti (tubo interno), mm</i>	19	19	-	
Exhaust air hose (external hose), mm <i>Tubo di scarico (tubo esterno), mm</i>	42	42	-	
Amalgam separator <i>Separatore di amalgama</i>	AS02	AS02	-	
L x W x H cm	product <i>prodotto</i>	33 x 56 x 46 30 kg 1 pc	33 x 56 x 46 32 kg 1 pc	27 x 17 x 18 1,9 kg
	package <i>Imballo</i>	55 x 34 x 64 18 kg 1 pc	55 x 34 x 64 24 kg 1 pc	29 x 28 x 18 2,2 kg
	full pallet	120 x 80 x 140 160 kg 8 pc	120 x 80 x 140 207 kg 8 pc	

SW-Mi3000



1,10 kW (1,48 hp)
1,10 kW (1,48 hp)

270 mbars
270 mbar

Ultra-quiet 55 dB(A)
Ultra-silenzioso 55 dB(A)

- ▶ 50% energy saving
50% di risparmio energetico
- ▶ Electronic PLC to control rpm, current consumption, working hours, vacuum indicator
Centralina elettronica di controllo (PLC) parametri di funzionamento: RPM, assorbimento energetico, ore di lavoro, indicatore di vuoto
- ▶ Does not require water supply
Non richiede approvvigionamento idrico
- ▶ Air/liquid separation unit
Separatore aria/liquido
- ▶ Automatic drain valve
Valvola di scarico automatica
- ▶ Can be fitted with amalgam separator
Integrabili con separatore di amalgama

- ▶ Variable-frequency drive (1800 – 3200 rpm)
Velocità variabile tramite inverter (1800 – 3200 rpm)
- ▶ Predisposed for Industry 4.0 connection
Predisposta per connessione Industry 4.0
- ▶ Wi-fi connection and remote control interface via software/app
Connessione Wi-fi e interfaccia di controllo in remoto tramite software/app

AS02

AMALGAM SEPARATOR SEPARATORE DI AMALGAMA



- ▶ 100% recyclable
100% riciclabile
- ▶ No power required
Nessuna connessione elettrica
- ▶ Does not require maintenance
Nessuna manutenzione richiesta
- ▶ Separation rate 96,6%
Livello di separazione 96,6%
- ▶ ISO 11143:2008

	SW-Mi3000	AS02	
Users <i>Postazioni</i>	1 - 3	-	
V - Hz	230 - 50/60	-	
kW (hp)	0,90 - 1,10 (1,21 - 1,48)	-	
Nominal current, A <i>Consumo, A</i>	6,2 - 7,4	-	
rpm	2900 - 3440	-	
Max vacuum, mbars <i>Vuoto max, mbar</i>	140 - 270	-	
Max liquid inlet, L/min <i>Entrata liquido massima, L/min</i>	11 - 13	-	
Suction inlet (internal hose), mm <i>Entrata aspirazione (tubo interno), mm</i>	38	-	
Waste outlet (internal hose), mm <i>Uscita rifiuti (tubo interno), mm</i>	19	-	
Exhaust air hose (external hose), mm <i>Tubo di scarico (tubo esterno), mm</i>	42	-	
Amalgam separator <i>Separatore di amalgama</i>	AS02	-	
L x W x H cm	product <i>prodotto</i>	33 x 56 x 46 35 kg 1 pc	27 x 17 x 18 1,9 kg
	package <i>Imballo</i>	55 x 34 x 64 24 kg 1 pc	29 x 28 x 18 2,2 kg
	full pallet	120 x 80 x 140 207 kg 8 pc	

ENVIRONMENTAL DISINFECTION SYSTEMS *SISTEMI DI SANIFICAZIONE AMBIENTALE*

DECO SERIES



DECO 1D

With manual nebulizing spray gun
Con aerografo nebulizzatore manuale

DECO 2

With automatic fogging machine
Con nebulizzatore automatico

DECO 3

With automatic fogging machine
Con nebulizzatore automatico



DECO 1D

7 L/H



DECO 2

1 L/H



DECO 3

6 L/H

- ▶ Extra dry, non-wetting misting
Nebulizzazione extra dry (asciutta)
- ▶ Lightweight and portable
Leggeri e portatili
- ▶ Effective on all surfaces
Efficaci su tutte le superfici
- ▶ Adjustable timer for automatic shutdown when work is completed
(Models DECO 2 and DECO 3)
*Timer regolabile per lo spegnimento automatico a fine lavoro
(Modelli DECO 2 and DECO 3)*
- ▶ Manual/automatic disinfection
Sanificazione manuale/automatica

	DECO 1D	DECO 2	DECO 3	
COMPRESSOR <i>COMPRESSORE</i>				
V - Hz	230 - 50	230 - 50	230 - 50	
kW (hp)	0,75 (1,00)	0,75 (1,00)	1,80 (2,50)	
L/min	70 @ 3 bars	85 @ 5 bars	150 @ 5 bars	
Max pressure, bars <i>Pressione max, bar</i>	3	8	10	
dB(A)	72	67	64	
Tank, lt. <i>Serbatoio, lt.</i>	-	10	3	
NEBULIZER <i>NEBULIZZATORE</i>	FOG 1 manual <i>FOG 1 manuale</i>	FOG 2 automatic <i>FOG 2 automatico</i>	FOG 3 automatic <i>FOG 3 automatico</i>	
Liquid delivery, L/H <i>Erogazione liquido, L/H</i>	7	1	6	
Max pressure, bars <i>Pressione max, bar</i>	3	5	5	
Droplet size, µm <i>Dimension nebbia, µm</i>	30	3,5 - 20	3,5 - 20	
Canister, lt. <i>Serbatoio, lt.</i>	1,00 (aluminum) <i>1,00 (alluminio)</i>	1,0 (plastic) <i>1,0 (plastica)</i>	10 (plastic) <i>10 (plastica)</i>	
Spiral hose m <i>Tubo spirale m</i>	Included 10 <i>Inclusa 10</i>	Included 3 <i>Inclusa 3</i>	Included 10 <i>Inclusa 10</i>	
Adjustable cut-off timer <i>Timer di spegnimento regolabile</i>	-	Included <i>Inclusa</i>	Included <i>Inclusa</i>	
Air consumption L/min <i>Consumo aria L/min</i>	60	60	110	
L x W x H cm	product <i>prodotto</i>	27 x 16 x 26 7 kg 1 pc	37 x 37 x 50 18 kg 1 pc	47 x 40 x 60 32 kg 1 pc
	package <i>imballo</i>	44 x 22 x 42 12 kg 1 pc	80 x 60 x 65 28 kg 1 pc	48 x 41 x 60 37 kg 1 pc
	full pallet	120 x 92 x 180 480 kg 12 pc	120 x 80 x 180 350 kg 12 pc	120 x 80 x 180 310 kg 8 pc

FOG 1



Manual nebulizing spray gun
Aeorografo nebulizzatore manuale

- ▶ Includes pressure stabilizer and 10 m spiral hose
Stabilizzatore di pressione e tubo spirale da 10 m inclusi
- ▶ Air consumption: 60 L/min
Consumo aria: 60 L/min

FOG 2



Automatic fogging machine
Nebulizzatore automatico

- ▶ Up to 40 m³ application volume
Volume di applicazione fino a 40 m³
- ▶ Includes 3 m polyurethane hose
Tubo in poliuretano da 3 m incluso
- ▶ Air consumption: 60 L/min
Consumo aria: 60 L/min

FOG 3



Automatic fogging machine
Nebulizzatore automatico

- ▶ Up to 400 m³ application volume
Volume di applicazione fino a 400 m³
- ▶ Includes 0,5 m polyurethane hose
Tubo in poliuretano da 0,5 m incluso
- ▶ Air consumption: 110 L/min
Consumo aria: 110 L/min

ACCESSORIES AND SERVICE PARTS

ACCESSORI E RICAMBI

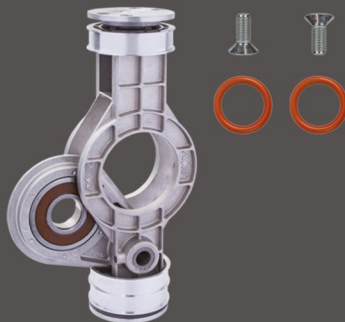
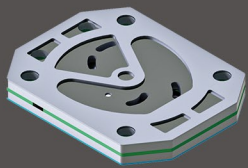

PICK-UP 1.05

Oil-free piston compressor
Compressore a pistone a secco



MADE IN ITALY
3-YEAR WARRANTY
GARANZIA 3 ANNI

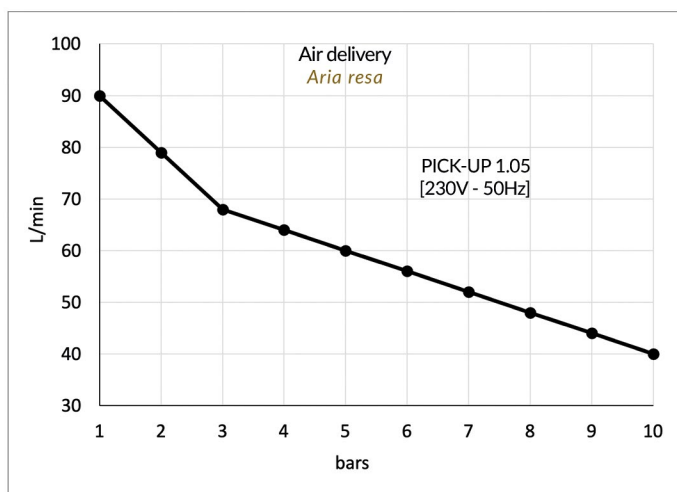

V - Hz	230 - 50	
kW (hp)	0,75 (1,00)	
rpm	2800	
Nominal current, A <i>Consumo, A</i>	4	
Cylinders <i>Cilindri</i>	1	
L/min @ 5 bars	60	
Max pressure, bars <i>Pressione massima, bar</i>	8	
Duty cycle <i>Ciclo di lavoro</i>	S3 - 70%	
Tank, lt. * <i>Serbatoio, lt.</i>	5	
dB(A)	72	
L x W x H cm kg	product <i>prodotto</i>	19 x 41 x 39 11 1 pc
	package <i>Imballo</i>	44 x 23 x 42 13 1 pc
	full pallet	120 x 92 x 180 480 40 pc

* Steel tank, epoxy coating (internal/external)
Serbatoio in acciaio, verniciatura epossidica (interno/esterno)

2006/42/EC 2014/29/UE 2014/30/UE 2014/35/UE

VLG.01

Trolley



- Used to carry PICK-UP 1.05 compressor
Usato per trasportare compressore PICK-UP 1.05
- Heavy-duty polyester fabric
Fabbricato in resistente cordura
- External and internal pockets
Tasche interne ed esterne
- Strong zipper
Chiusura a zip
- Securely mounted short handle
Maniglie per il trasporto a borsa
- Telescoping handle
Manico telescopico
- 4 wheels (front spinning wheels)
4 ruote (ruote frontali girevoli)
- Compressor sold separately
Compressore venduto separatamente

GF01001

Moisture control filter and pressure regulator
with double air-outlet connectors

*Filtro-regolatore anti-condensa
con doppia uscita aria*

- All CLINIC 12.500 models
Tutti i modelli CLINIC 12.500

**GF01002**

Pressure regulator

Regolatore di pressione

- All models except CLINIC 12.500
Tutti i modelli tranne CLINIC 12.500

**GF01003**

Moisture control filter and pressure regulator

Filtro-regolatore anti-condensa

- All models except CLINIC 12.500
Tutti i modelli tranne CLINIC 12.500

**AR003409**

Stainless Steel Valve Plates Kit

Kit valvole in acciaio inox

- All SMART 3.25-S and CLINIC 3.40 models
Tutti i modelli SMART 3.25-S and CLINIC 3.40

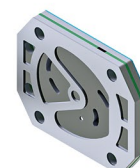
**AR003410**

Stainless Steel Valve Plates Kit

Kit valvole in acciaio inox

- All CLINIC 6.90 and 12.500 models
Tutti i modelli CLINIC 6.90 e 12.500

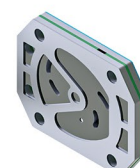
**84212**

Tank automatic drain kit (capacitive)

Kit scaricatore automatico serbatoio (capacitivo)

- All SMART and CLINIC models except CLINIC 12.500
Tutti i modelli SMART e CLINIC eccetto CLINIC 12.500

**84215**







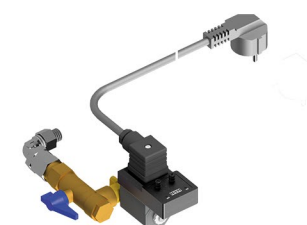









Tank automatic drain kit
with electronic valve and timer

*Kit scaricatore automatico serbatoio
con valvola elettronica e timer*







- All CLINIC 12.500 models
Tutti i modelli CLINIC 12.500









1 Rings and gaskets kits Kit ring e guarnizioni

	83200
	83215
	84300
	84301
	84303
	85205
	85207
	85210
	85211
	86201
	86202
	86203
	86204
	86205
	86206
	87200

2 Piston kits Kit pistone

	83209
	83212
	83213
	83214
	83216
	85203

3 Air intake filters Filtri d'aspirazione

	M0107
	85041/8
	85042/6
	85042/7
	85042/8
	83045/1

4 Silica gel kit Kit gel di silice

	84053/1
---	---------

5 Moisture control filter cartridges Cartucce per filtro anticondensa

	84211
	9251709

6 Sterilizing filter cartridge Cartuccia per filtro antibatterico

	84023
---	-------



7 Excentric shaft puller Estrattore albero eccentrico

	83124
---	-------

8 Piston pullers Estrattori pistone

	83125
	83136

9 Wheels Ruote

	83032 160 x 35 mm, Ø 20 mm	10 pc	MOQ
	83035/1 220 x 75 mm, Ø 25 mm	10 pc	

Pressure switches Pressostati

	MOQ
213635 Condor MDR 1, 110V, 230V	10 pc
226468 Condor MDR 2, 110V, 230V	10 pc
275022 Condor MDR 3, 230V	10 pc
272014 Condor MDR 3, 400V	5 pc
PM3VVRP7/9 Nema 230V	10 pc
83174 - Danfoss 060-110866 (+2/+14 bars)	1 pc

Pressure switches with timer Pressostati con timer

	MOQ
83059 Automatic/Automatiko	1 pc
83059/3 Adjustable/Regolabile 1pc	1 pc

Pressure switches with timer Pressostati con contaore

	MOQ
206064 Condor MDR 2, 110V, 230V	1 pc
206590 Condor MDR 3, 230V	1 pc
206682 Condor MDR 3, 400V	1 pc

AXXER	COMPACT	CLINIC	SERVICE PARTS FOR CURRENT MODELS <i>RICAMBI PER MODELLI ATTUALI</i>								
			1	2	3	4	5	6	7	8	9
B60	-	-	85211	-	85042/8	-	-	-	-	-	-
B70	-	-	87200	85203	M0107	-	-	-	-	-	-
B100	-	-	85210	-	85042/7	-	-	-	-	-	-
B110	B110/05	PICK-UP 1.05	87200	85203	M0107	-	-	-	83124	83124	-
B150	B150/10	SMART 1.25	85207	-	85042/6	-	-	-	-	-	-
-	-	SMART DRY 1.25	85207	-	85042/6	84053/1	-	-	-	-	-
B220	B220/20	SMART 2.25	85205	-	85041/8	-	-	-	-	-	-
-	-	SMART DRY 2.25	85205	-	85041/8	84053/1	-	-	-	-	-
-	-	SMART 4.90	85205	-	85041/8	-	-	-	-	-	-
-	-	SMART DRY 4.90	85205	-	85041/8	84053/1	-	-	-	-	-
C120	-	-	84301	83216	M0107	-	-	-	83124	83124	-
CS120	-	SMART 1.25-S	84301	83216	83045/1	-	-	-	83124	83124	-
-	-	SMART DRY 1.25-S	84301	83216	83045/1	84053/1	-	-	83124	83124	-
C330	C330/XX MODELS	-	83200	83209	M0107	-	-	-	83124	83124	-
-	C480/100	-	83200	83209	M0107	-	-	-	83124	83124	-
-	C660/100	-	83200	83209	M0107	-	-	-	83124	83124	-
CK330	CK330/100	-	83215	83213	M0107	-	-	-	83124	83124	-
EK480	EK480/XX MODELS	-	86204	83213	M0107	-	-	-	83124	83124	-
EK660	EK660/XX MODELS	-	86202	83213	M0107	-	-	-	83124	83124	-
-	EK1320/500 MODELS	-	86205	83213	M0107	-	-	-	83124	83124	-
CSK240	-	-	84303	83214	83045/1	-	-	-	83124	83124	-
CSK330	CSK330/XX MODELS	SMART 3.25-S	84303	83214	83045/1	-	-	-	83124	83124	-
-	-	SMART DRY 3.25-S	84303	83214	83045/1	84053/1	-	-	83124	83124	-
-	-	CLINIC 3.40	84303	83214	83045/1	-	-	-	83124	83124	-
-	-	CLINIC DRY 3.40 H	84303	83214	83045/1	-	84211	-	83124	83124	-
-	-	CLINIC DRY 3.40 HS	84303	83214	83045/1	-	84211	84023	83124	83124	-
ESK480	ESK480/XX MODELS	CLINIC 6.90	86203	83214	83045/1	-	-	-	83124	83124	-
-	-	CLINIC DRY 6.90 H	86203	83214	83045/1	-	84211	-	83124	83124	-
-	-	CLINIC DRY 6.90 HS	86203	83214	83045/1	-	84211	84023	83124	83124	-
-	-	CLINIC 12.500	86203	83214	83045/1	-	-	-	83124	83124	-
-	-	CLINIC DRY 12.500 H	86203	83214	83045/1	-	84211	-	83124	83124	-
-	-	CLINIC DRY 12.500 HS	86203	83214	83045/1	-	84211	84023	83124	83124	-
ESK660	ESK660/XX MODELS	-	86203	83214	83045/1	-	-	-	83124	83124	-
-	ESK960/500 MODELS	-	86206	83214	83045/1	-	-	-	83124	83124	-
-	ESK1320/500 MODELS	-	86206	83214	83045/1	-	-	-	83124	83124	-
COMPACT MODELS B220/20, C330/03, CSK240/03			-	-	-	-	-	-	-	-	83032
ALL OTHER COMPACT MODELS			-	-	-	-	-	-	-	-	83035/1
			SERVICE PARTS FOR DISCONTINUED MODELS <i>RICAMBI PER MODELLI DISMESSI</i>								
			1	2	7	8					
CS240 CS240/24, /50			84300	83212	83124	83125					
ES480 ES480/100			86201	83212	83124	83125					
ALL CLINIC 3.24 AND CLINIC 3.50 MODELS (UNTIL 2017)			84300	83212	83124	83125					
CLINIC 6.90, CLINIC DRY 6.90 H, CLINIC DRY 6.90 HS (UNTIL 2017)			86201	83212	83124	83125					

MAIN OFFICE / Sede Legale

Gentilin srl

Via delle Tezze, 20/22

36070 Trissino VI – Italy

Phone: +39 0445 962 000

Fax: +39 0445 491 412

Email: info@gentilinair.com



www.gentilinair.com
www.clinic-air.com

USA OFFICE

Gentilin srl

PO BOX 511191

Milwaukee, WI 53203

Phone: +1 414-248-1976

Fax: +1 414-395-8138

Email: americas@gentilinair.com